

13/16 U-Frame

Note: This size includes SEPU
Slots in standard pricing

U-FRAME

Catalog #	13/16 UF 321
-----------	--------------

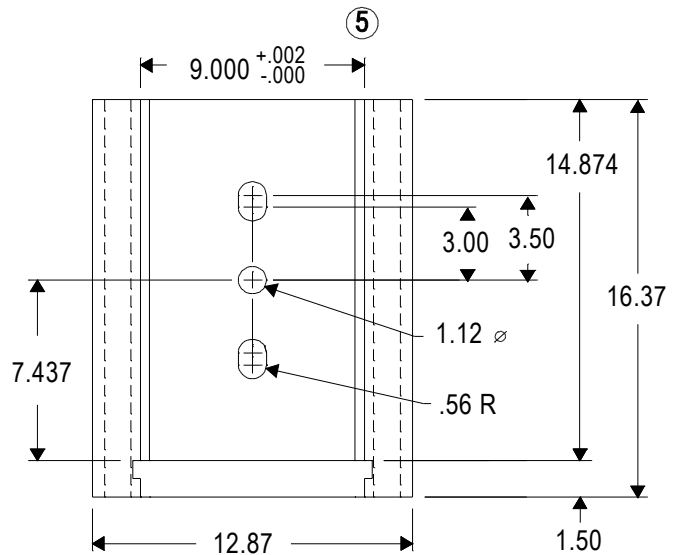
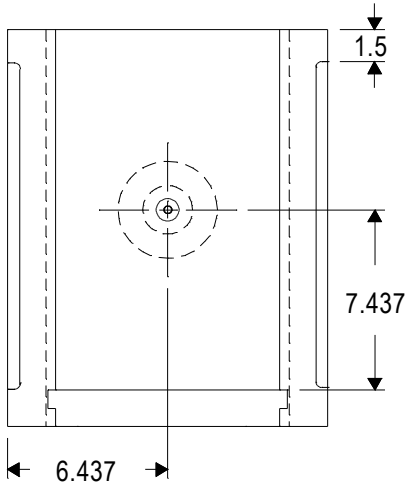
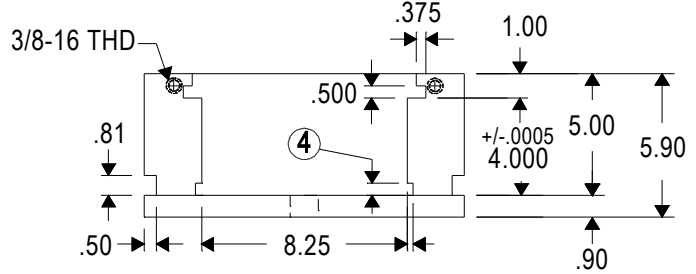
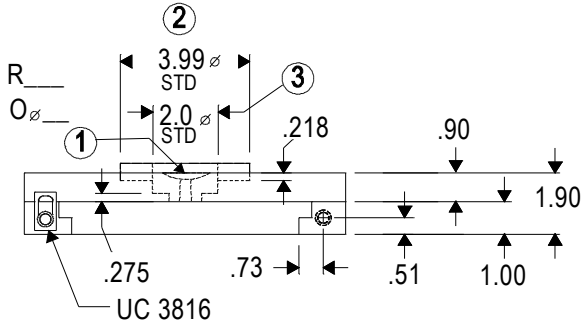

- ① Sprue Bushing information:
O=Small Dia. of Sprue Bushing Orifice: 5/32", 7/32", 9/32"
R=Spherical Radius of Sprue Bushing: 1/2" or 3/4"
- ② Optional Locating Rings are available (Industry Standard)

- ③ 2" or 2½" clearance through hole is available (No Sprue Bushing)
- ④ Tapered Slot at .25 Degree to accommodate Sleeve Ejector Plate (SEPU)
- ⑤ 3/8 X 5 Degree Lead-in

ORDERING INFORMATION

frames

- Please specify Quantity & Catalog #
- Specify Locating Ring Diameter & Sprue Bushing R & O sizes
- Standard Material for Frames is 4140 Prehard

Inserts

- Please specify Quantity & Catalog #
- Steel grades available: P-20 Prehard or 4140 Prehard (Other grades available upon request)
- Optional "A", "A2", "B2", & "B" thickness'

(See compatible inserts on opposite page →)

Cross Tool & Manufacturing, Inc.
1-800-832-3993
crosstool.com